

DOGTM
T R A C E

DOG | X₂₅
G P S

X25 • X25B • X25T • X25TB

GPS TRACKING SYSTEM
SISTEMA DI LOCALIZZAZIONE GPS
SISTEMA DE LOCALIZACIÓN GPS
GPS SYSTÈME DE REPÉRAGE

ENGLISH

ITALIANO

ESPAÑOL

FRANÇAIS

DECLARATION OF CONFORMITY**We:**

VNT electronics s.r.o.

Dvorská 605

563 01 Lanškroun

IČO: 64793826

declare under own responsibility that the product:

Dogtrace**DOG GPS X25 and X25T, X25B and X25TB**

is in compliance with the essential requirements and other relevant provisions of Directive 2014/53/EC, meets requirements of General Licence of The Czech telecommunication office according to general licence no. VO-R/10/05.2014-3 and corresponds to the following standards:

ETSI EN 301 489-1 V1.9.2**ETSI EN 301 489-3 V1.6.1****ETSI EN 300 220-2 V.2.4.1****ETSI EN 60950-1 ed.2:2006/A1:2010/A11:2009/A12:2011/A2:2014/Cor.1:2012****EN 62479:2010**

The product is safe under conditions of standard use in accordance with the user guide.

This declaration of Conformity is created in exclusive responsibility of producer.

In Lanškroun 1. 8. 2023

Ing. Jan Horák

executive director

Tel.: +420 461 310 764

info@dogtrace.com

www.dogtrace.com

Thank you for purchasing the product DOG GPS of the trademark Dogtrace from VNT electronics s.r.o., Czech Republic.

Before using your product, please read the instructions in this user guide carefully and keep it for future reference.

VNT electronics s.r.o. hereby declares that the **Dogtrace DOG GPS X25** is in compliance with the key requirements and other relevant provisions of the Directive 2014/53/EC.

1		CONTENT	
2	Important advice	4
3	ECMA	4
4	Introduction	5
4.1	DOG GPS X25 features	5
4.2	Package contents	5
5	Equipment description	6
5.1	Transmitter (collar)	6
5.2	Receiver (handset)	6
5.3	Power adapter and cable with charging clip	9
6	Preparing transmitter (collar)	9
6.1	Charging the transmitter	9
6.2	Checking battery charge status	9
6.3	Turning on/off	9
6.4	Frequency of position updating (transmission)	10
6.5	Selecting contact points	10
6.6	Fitting the collar	11
7	Preparing receiver (handset)	11
7.1	Charging the receiver	11
7.2	Checking battery charge status	12
7.3	Setting the receiver	12
7.4	Receiver MENU	12
7.5	Pairing – encoding transmitter (collar) with receiver (handset)	13
7.6	Pairing – encoding another receiver (handset) with your receiver	13
7.7	Setting the sound volume	14
7.8	Digital compass calibration	14
7.9	Channel selection	15
8	DOG GPS X25 features	16
8.1	Tracking	16
8.2	Training	17
8.3	Compass feature – determining the North	18
8.4	FENCE – circular fence	18
8.5	WAYPOINT – saving receiver's position	19
8.6	BEEPER – indicating standing still	20
8.7	CAR mode	21
9	Maximum GPS range and accuracy	22
10	Troubleshooting	22
11	Device maintenance	23
12	Technical specifications	23
13	Displayed texts on LCD	24
14	Warranty Terms and Conditions	26
15	Certificate of Warranty	108

2

IMPORTANT ADVICE

- Please read this Operating Manual carefully before using the product.
- Do not leave the neck collar transmitter on a dog for more than 12 hours a day. Long-term effects caused by the collar and contact points on the dog's skin may cause irritation. If this occurs, do not use DOG GPS until all traces of irritation disappear.
- Do not place the receiver or the transmitter near objects sensitive to magnetic field, as this may cause permanent damage.
- Do not place the receiver near any device, which is generating magnetic field as it may affect the internal digital compass.
- The receiver and the transmitter include a rechargeable Li-Pol battery. If the DOG GPS is not used for long time, its batteries must be recharged every 6 months.
- Do not charge the batteries at temperatures above 40 °C – explosion hazard.
- Protect the Li-Pol battery from damage by sharp objects, high mechanical pressure or high temperatures as it could cause the battery bursting into flames or explode.
- Use only the original batteries; different batteries may damage the product or cause the batteries to explode.
- Use only the original power adapter with charging clip for charging the receiver and transmitter batteries.
- Dispose of used batteries in designated locations.
- Person fitted with cardiac pacemaker (pacemaker, defibrillator) must take appropriate precautions as the DOG GPS emits specific static magnetic field.
- X25B and X25TB transmitters include audio position finder, which emits loud sound. Do not use this function in an enclosed space as it may damage hearing.

3

ECMA



VNT electronics s.r.o., manufacturer of **Dogtrace** professional training tools for dogs, is the proud and active member of the **Electronic Collar Manufacturers Association (ECMA)**.

ECMA, based in Brussels, was founded in 2004 at the initiative of the largest manufacturers of electronic training aids for dogs. The aim of all members of this association is to develop and produce quality and reliable training systems that ensure safety of the animal and improve communication between the owner and his/her dog. All ECMA members' products meet the latest technical standards and safety parameters and their adherence is strictly monitored.

For more information, please visit the following website: www.ecma.eu.com.

DOG GPS X25+ is a device for tracking (locating) your dogs for up to 20 km. It consists of the transmitter located on the dog's collar and the receiver (handset) on which the dog handler tracks the distance and direction towards the dog's location. The transmitter gets its position from the GPS satellites, which send the position data to the dog handler's receiver via the radio frequency (RF) signal. X25B/X25TB transmitters include audio position finder by which a dog may be identified up to a distance of 300 m. The transmitter may include training module (kit designated X25T/X25TB), which enables the stimulation pulse to be sent from the receiver for up to 20 km.

The DOG GPS X25 also has additional features – compass, FENCE (circular fence) which provides information that the dog moved beyond the set distance from the receiver. It also has the BEEPER (detecting standing still), which simply enables to determine whether the dog is moving or standing still and Waypoint function (waypoint/route point), which enables saving the receiver's position and subsequently navigating to it.

4.1 DOG GPS X25+ features

- Range between the transmitter and the receiver is up to 20 km in direct visibility (depending on terrain, vegetation and other factors)
- Tracking up to 19 dogs, hunters or waypoints
- Highly sensitive GPS in the receiver and transmitter
- Clearly legible receiver display – in direct sunlight and in the dark
- Waterproof receiver and transmitter
- Long battery life
- 2 acoustic signal modes – training / localization
- Option to switch the tone type of the acoustic signal.
- Loud location sound audible up to 300 m (X25B/X25TB transmitters only)
- 15 stimulation pulse levels (GPS X25T/X25TB only)
- Light mode for identifying dog in the dark (GPS X25T/X25TB only)
- Switching channels for communication between the transmitter and receiver
- Compass feature
- FENCE (circular fence) – indicates that the set distance from the dog handler has been exceeded
- BEEPER – detection of dog in motion/standing still
- Waypoint – option to store 19 GPS receiver coordinates – navigation to these points
- CAR mode – mode for using the receiver (handset) in the vehicle
- Receiver is compatible with all DOG GPS transmitters (collars). Some functions on X20 are restricted

4.2 Package contents

- Receiver including Li-Pol 1900 mAh battery
- Clip for hanging the receiver on a belt and two screws
- Transmitter including Li-Pol 1900 mAh and the belt

- Set of contact points, 2 pcs 10 mm, 2 pcs 17 mm (DOG GPS X25T/X25TB only)
- Dual power adapter, two USB cables with GPS charging clip
- Test discharge lamp (DOG GPS X25T/X25TB only)
- Cord for handing the receiver
- Operating Manual and Certificate of Warranty
- Equipment bag

5

EQUIPMENT DESCRIPTION

5.1 Transmitter (collar)

- | | |
|---|--|
| 1. Transmitter | 6. RF aerial |
| 2. Indicator lights | 7. GPS aerial |
| 3. Charging contacts | 8. Belt (collar) |
| 4. Training module with contact points (DOG GPS X25T/X25TB only) | 9. Loudspeaker (DOG GPS X25B/X25TB only) |
| 5. Target (half-round red dot) for applying magnet (switching on/off the transmitter) | |

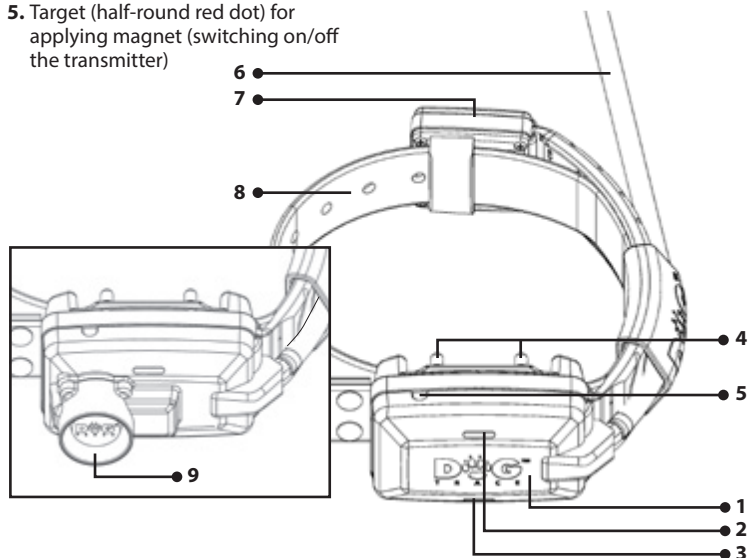

5.2 Receiver (handset)

- | | |
|--|-----------------------------------|
| 1.–5. Push buttons (see table, Page 7) | 10. Clip for hanging on a belt |
| 6. RF aerial | 11. Point for attaching neck cord |
| 7. GPS aerial | 12. Charging contacts |
| 8. Display | |
| 9. Target (half-round red dot) indicating location for magnet to switch the transmitter on/off | |

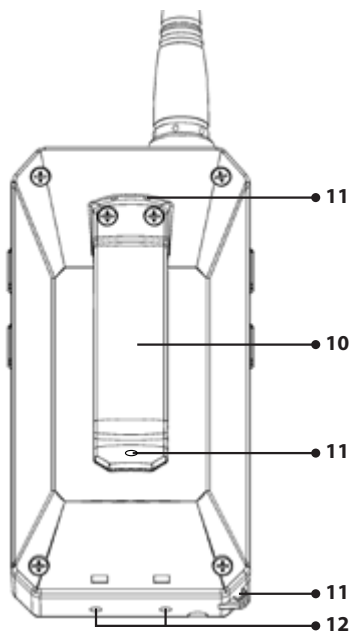
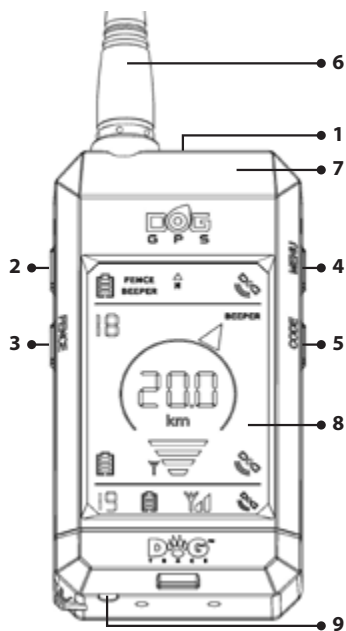

Button	Short press		Long press	
	Icon	Action	Icon	Action
1		Turning display backlight on/off		Switching the transmitter on/off
2		Training audible beep tone		Training audible beep tone
3		Back to the main screen	FENCE	Enabling the circular fence
4		Upwards	MENU	Entering MENU (setting)
5		Downwards	CODE	Pairing – encoding the transmitter with the receiver/ storing the waypoints
2+3			+	Stimulation impulse
3+5			+	CL – digital compass calibration
2+4			+	Location beep tone

Display

1. Receiver (handset) GPS position accuracy
2. Transmitter (collar) GPS position accuracy
3. Another transmitter GPS position accuracy
4. RF signal strength received from a transmitter
5. RF signal strength received from another transmitter
6. Direction indicator to the paired transmitter
7. Number of selected paired transmitter
8. Number of another paired transmitter
9. Receiver battery charge status
10. Transmitter battery charge status
11. Another transmitter battery charge status
12. Distance between the transmitter and receiver
13. Compass – direction towards the magnetic North
14. Vibrating or acoustic indication of standing still on one of the transmitters
15. Active circular fence on one of the dogs
16. Active indicating standing still
17. Active circular fence
18. Transmission channel to full capacity
19. Another paired receiver (dog handler)

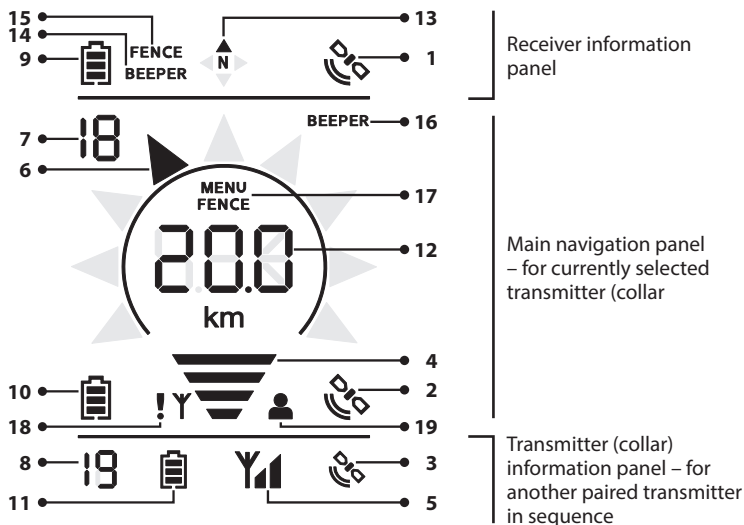

5.3 Power adapter and cable with charging clip

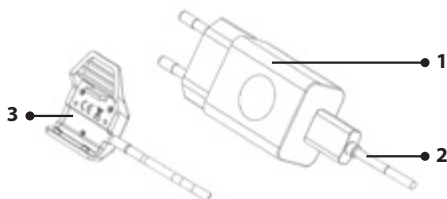

1. Power adapter
2. USB cable
3. Charging clip

6 PREPARING TRANSMITTER (COLLAR)

6.1 Charging the transmitter

GPS transmitter includes Li-Pol battery, which must be charged before the first use.

1. Remove dirt from charging contacts. Connect the charging clip to the transmitter (see figure).
2. Connect cable to the power adapter, which is then plugged into the mains.
3. Orange indicator light is illuminated.
4. Charging takes approximately 3 hours.
5. Orange light goes off when charging is finished.

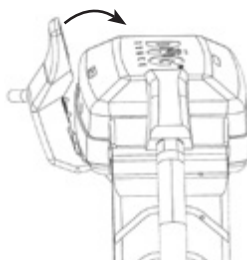

WARNING: Charge the battery at temperatures between 0 °C to 40 °C. Use only the original power adapter supplied by the manufacturer for charging as using different one may lead to irreparable battery damage.

6.2 Checking battery charge status

Flashing indicator lights located on the top of the transmitter (see Paragraph 5.1 *Equipment Description – Transmitter*) or the battery symbol on the receiver (handset) display are used to check the battery charge status.

Charge status	Receiver	Transmitter
100%		Green indicator light
70%		—
40%		Simultaneously green and red indicator lights
10%		Red indicator light

6.3 Turning on/off

Magnetic switching system, activated by applying magnet, is used for switching the transmitter on/off. The magnet is fitted in the receiver where the red target is located (half-round red dot located on the bottom of the receiver).

Turning on:

1. Place the red target located on the bottom of the receiver to the red target on the transmitter for approximately 1 second – the red indicator light comes on and subsequently the green indicator light is lit.
2. After the green indicator light is lit, move the receiver away from the transmitter. The green indicator light starts flashing.

Turning off:

Proceed in the same manner as for switching on.

1. Place the red target located on the bottom of the receiver to the red target on the transmitter for approximately 1 second – the green indicator light comes on and subsequently the red indicator light is lit.
2. After the red indicator light is lit, move the receiver away from the transmitter. The transmitter stops flashing.

6.4 Frequency of position updating (transmission)

DOG GPS X25 enables selecting the updating frequency of your dog's position. When the collar transmits its position more frequently, the location of the dog is known more frequently.

1. Switch off the transmitter (collar).
2. Place the red target located on the bottom of the receiver to the red target on the transmitter for 3 seconds – the transmitter starts beeping. Select the updating frequency according to the number of beeps – see the table below.

Number of beeps	1	2	3
Updating frequency [s]	3	6	9

3. Select the frequency by moving the receiver away from the transmitter when the required number of beeps is heard.

NOTE: Frequency may also be changed remotely from the receiver. Receiver settings may be found in **MENU** / **UPDRE E INF E** / **C 1 – C 19** . Options may be found in the table, Paragraph 7.4. .

WARNING: More frequent updating of the dog's position results in quicker discharging of the transmitter battery.

6.5 Selecting contact points (GPS X25T/X25TB)

Stainless contact points are used for the transmission of stimulation pulses from the transmitter to the dog's skin. Each pack contains two types. If your dog has short hair use the short contact points, use the longer ones if you have dog with longer or thicker hair. Screw the contact points onto the transmitter screws – see Fig. 5.1 *Transmitter (collar)* in the *Equipment Description* paragraph, Page 6. Tighten the contact points by hand. Do not use pliers or other tools for tightening as it may cause irreparable damage to the product.

6.6 Fitting the collar

Fit the collar with the GPS transmitter to the dog so that the GPS and RF aerials are pointing upwards (see figure). The collar must be sufficiently tightened as not to rotate on the dog's neck but to enable the dog to naturally breathe and receive food. If the training module (X25T/X25TB kit) is part of the transmitter, it is essential to ensure good contact between the contact points and the dog's skin. We recommend fitting the collar on a dog at rest. If the dog has long or dense hair, it is advisable to cut the coat at the point where contact points touch the skin or use the longer contact points. Long-term effects caused by the collar on the dog's skin may cause irritation. If this occurs, do not use the DOG GPS until all traces of irritation disappear.

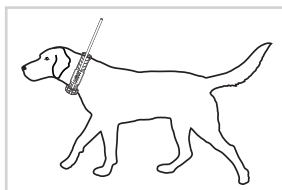

WARNING: If the collar is too loose, the transmitter is likely to move and repeated friction may irritate your dog's skin. Furthermore, in this case, the contact points may not touch the skin surface in required manner and consequently, the training module may not function correctly. We do not recommend keeping the dog's collar at the same place for several hours as it could cause skin irritation. If it is necessary for your dog to wear the collar for a long time, change the position of the transmitter on the neck regularly. If the collar with the transmitter is too tight, it may cause pressure sores where the contact points touch the skin. If this occurs, do not use the training module until all traces of irritation disappear.

7 PREPARING RECEIVER (HANDSET)

7.1 Charging the receiver

GPS transmitter includes Li-Pol battery, which must be charged before the first use.



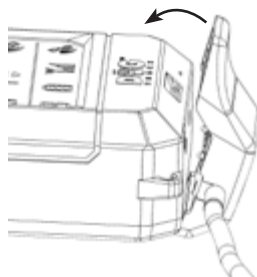

1. Remove dirt from charging contacts. Connect the charging clip to the receiver (see figure).
2. Connect cable to the power adapter, which is then plugged into the mains.
3. Display shows gradually increasing number of horizontal bars in the battery symbol.
4. Charging takes approximately 3 hours.
5. Battery is fully charged when the battery symbol is full – see below.





WARNING: Charge the battery at temperatures between 0 °C to 40 °C. Use only the original power adapter supplied by the manufacturer for charging as using different one may lead to irreparable battery damage.

7.2 Checking battery status

The battery status in the receiver is indicated by the battery symbol in the **receiver information panel** – the top line of the display.

Charge status	Receiver
100%	
70%	
40%	
10%	

7.3 Setting the receiver

- Switching on/off – hold the  push button for 2 seconds
- To select a dog, press **A/V**.
- To turn the display backlight on/off, briefly press , the backlight will be lit for 15 minutes, then switches off automatically.

7.4 Receiver MENU

Long press of the **MENU** push button enters settings of several features. Another long press of the **MENU** push button confirms the selected menu item. To return to the higher level, press the  push button briefly.

The following table shows the full **MENU** structure.

MENU level					Chapter	
1	2	3	4	5		
bR in nG	[1-0 19	IMPULSE	0-15		8.2	
		tone	1-bR in nG* Loudness			1-4
			2-LOCAL ISAt ion* Loudness			1-4
			3-bR in nG tone			1-3
			4-LOCAL ISAt ion tone			1-3
FLASH	ON/OFF					
bEEPER	[1-0 19	mode	OFF		8.6	
			1-Point inG-t			
			2-Point inG-4			
			3-boAr-t			
		4-boAr-4				
5-run-t						
6-run-4						
SENS		1-9				
DELAY		1-4				
rAd iUS**		5-60m				
t iNE**		30/60/90/120s				

LoUdnESS	1-5			7.7
LocAt ion	ON/OFF			7.6
UPdAtE t INE	C 1-C 19	3/6/9		6.4
CHAnnEL	A/b			7.9
CAr Mode	ON/OFF			8.7

* Setting only applies to the X25B/X25TB transmitters

** Displayed when Boar Mode is set (boAR)

7.5 Pairing – encoding transmitter (collar) with receiver (handset)

1. Turn on the receiver and transmitter you wish to pair together – **switch other devices off.**
2. Hold the **CODE** push button on the receiver for 2 seconds.
3. Select the position to which you wish to pair the transmitter (collar) by using **▲/▼** arrows. If the position is empty (there is no paired transmitter, receiver or saved waypoint), the **NO CODE** message is shown on the display.
4. Hold the **CODE** push button again for 2 seconds.
5. Move the transmitter close to the receiver with the RF aerials parallel to each other.
6. After pairing, the **COLLAR SAVED** message is displayed and **C 1** to **C 19** is lit on the display (according to the selected position to which the transmitter is paired).
7. If you wish to pair another transmitter, **repeat the procedure from Point 3.**
8. To exit the coding mode press **↵**.

NOTE: To delete any of the paired transmitters (collars), receivers or waypoints from the receiver's memory, select the position and long press the button **↵**. The position will then display **NO CODE**.

NOTE: The receiver X25 is possible to pair with X20 transmitters (collars). It is not possible to send training commands to these collars. Some other functions are limited.

NOTE: The X25 series transmitters (collars) can be paired with the X20 and X30 receivers, but will not transmit training commands to the collars – sound, stimulation pulse and light.

7.6 Pairing – encoding another receiver (hand set) with your receiver

DOG GPS X25 enables pairing of other dog handlers' receivers with your receiver and then track their position. Updating the position of other dog handlers in your receiver takes place every 60 seconds.

Turn on another receiver to transmit its position before pairing your receiver with this receiver commences.

1. Long press the **MENU** push button on the receiver you wish to track.
2. Select **LOCATE** by using **▲/▼** arrows and long press **MENU** again.
3. Select **ON** and by repeatedly pressing **↵** return to the main screen.

Now, you may start pairing this receiver with yours.

1. Turn on your receiver and the second receiver you wish to track – **transmitters (collars) in your vicinity must be turned off.**
2. Hold the **CODE** push button on both receivers for 2 seconds.
3. **On your receiver**, select the position to which you wish to pair the second transmitter (collar) using **▲/▼** arrows. If the position is empty (at given position there is no paired transmitter, receiver or saved waypoint), the **NO CODE** message is shown on the display.
4. Hold the **CODE** push button **on your receiver** again for 2 seconds.
5. Move both receivers close to each other with the RF aerials parallel to each other.
6. After pairing, the **HUNTER SAVED** message is displayed and **H I** to **I9** is lit on the display according to the selected position to which the receiver is paired.
7. To exit the coding mode press **↵** on both receivers.

NOTE: Another receiver paired to your receiver is indicated by the symbol  shown on the main LCD navigation panel.

7.7 Setting the sound volume

Receiver's sound volume may set to five levels.

1. Long press the **MENU** push button and select **LOUDNESS** using **▲/▼** arrows.
2. Select sound volume level using **▲/▼**.
3. By repeatedly pressing **↵** return to the main screen.

7.8 Digital compass calibration

For viewing the exact direction to the transmitter collar, it is crucial that the calibration is carried out correctly. If the device does not indicate the correct direction even with the maximum GPS accuracy (two bars on both signal indicators on the display), the calibration may not have been carried out for a long time or was carried out incorrectly.

NOTE: Carry out calibration in an open area, away from objects that emit magnetic field – buildings, cars, overhead and underground power lines.

Calibration procedure

If you know the direction to the North magnetic pole, you may go straight to Point 2.

1. To commence the calibration procedure simultaneously press both bottom push buttons **↵** and **▼** for two seconds. Then rotate the device several times around each of the three axes (see Figs. 1, 2 and 3). Finish calibration by pressing the back/return push button. To refine calibration proceed as per Point 2.
2. Find the North using the compass on the display and turn the receiver so that the aerial points to the North (see Fig. 4). To commence the calibration procedure simultaneously press the both bottom push buttons **↵** and **▼** for two seconds.

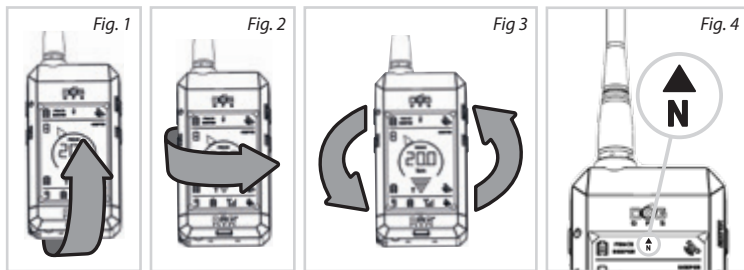

3. Carry out at least 10 rotations as per Figs. 5 and 6, whilst still pointing to the North. For quality calibration, each single rotation should be carried out with a slight deviation from the direction northwards (see Fig. 7). Greater number of and slower rotations will result in better calibration. Press the back/return push button ↵ to finish.

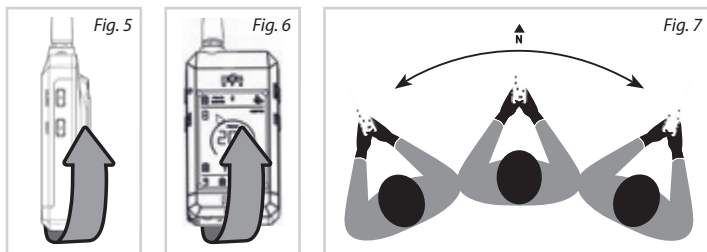

WARNING: The accuracy of the navigation rosette depends on the correct calibration of the digital compass. In the event that inaccurate indication of the dog's direction from you occurs, carry out calibration again.

The digital compass calibration will be lost if the receiver is located in the vicinity of another object's or device's magnetic field; in such event, the compass must be recalibrated.

NOTE: When the compass calibration is complete, the CAR mode function will be automatically disabled.

7.9 Channel selection

The number of active transmitters (collars) in the vicinity is restricted. In the event that a large number of DOG GPS transmitters are transmitting at the same time, some dog position messages send to your receiver may be lost. To increase the number of active transmitters in one area, set the updating frequency to 9 seconds (Paragraph 6.4). Nevertheless, if the position messages are lost, this status will be indicated on the DOG GPS X25 receiver by the ! symbol next to the RF signal strength indication.

In this case, switch your transmitters (collars) and the receiver to another channel. To change a channel, all transmitters (collars) must within close proximity – up to a maximum of 10 meters.

NOTE: Channel switching is only possible for X25/X25T/X25B/X25TB and X30/X30T/X30B/X30TB receivers and transmitters (collars). If any X20 collars are paired on the receiver, the receiver will not enable channel switching.

1. Turn on all transmitters and the receiver on which you wish to change channel.
2. Long press the **MENU** push button on the receiver.
3. Select **CHANNEL** using **▲** / **▼** arrows and long press the **MENU** push button again.
4. Firstly, currently selected channel is displayed; to change press **▲** / **▼** and select reverse **A** or **B**.
5. Long press the **MENU** push button to confirm the selection. Each transmitter will successively beep to indicate channel switching. One beep indicates switching to the channel **A** and two consecutive beeps to the channel **B**.
6. If the channel is changed correctly **OK** message will show on all transmitters' displays. If the change fails, the **ERROR** message will appear on the display. Repeat the whole procedure from the step number 4.
7. By repeatedly pressing **↶** return to the receiver's main screen.
8. Make sure that you receive RF signals from all your transmitters on your receiver. If no, try switching the channel again to the desired receiver **A**/**B**.

WARNING: If other receivers (dog handlers) are paired with your receiver, you will no longer be able to track them after changing the channel. These hunters would also have to switch their receivers and transmitters to the same channel.

8

DOG GPS X25 FEATURES

8.1 Tracking

The transmitter (collar) and the receiver (handset) have built-in GPS receiver by which both detect their position. The transmitter sends information about its position by means of the radio signal (RF) to the receiver, which shows the direction and dog's distance from the handler on the display.

Receiver display is divided into three parts:

- **Receiver information panel** – top line displays the receiver's data – battery charge status, GPS position accuracy, magnetic north direction (compass), switching on the BEEPER (indicating dog standing still) and FENCE (circular fence) features relating to one of the paired dogs.
- **Main navigation panel** – middle display section provides information about the currently selected transmitter (other receiver). Illuminated pointer arrow shows the direction to the tracked dog location. In the middle of the display, distance between the dog and the handler is shown. Different dogs are displayed by using the **▲**/**▼** push buttons.

- **Transmitter information panel** – bottom line shows data relating to the next paired transmitter in sequence – battery charge status, RF signal strength, GPS position accuracy.

NOTE: If the dog's direction and distance indicator flashes, the receiver has not received the GPS data for a long time or the receiver/transmitter has no GPS signal. In such case, the direction and distance to the last known position is indicated on the display.

WARNING: If the direction indicator does not point correctly towards your dog, recalibrate the digital compass.

Status indicated on the receiver's display:

 – Receiver has not received information from the transmitter relating to the dog's position for a long time.

 – If the RF signal strength indicator flashes, it signifies that it has received location data from the selected collar.

 – If only the RF aerial flashes – it does not receive any RF signal from the transmitter.

 – Receiver or transmitter does not have the GPS position.

 – No paired transmitter at the given position.

 – Receiver and transmitter are closer to each other than the accuracy of the GPS position.

8.2 Training



This feature enables correction of undesirable behaviour up to the distance of 20 km. The basic DOG GPS X25/X25B kit enables using the acoustic command. DOG GPS X25T/X25TB (training) kit is enhanced by the use of the correction stimulation impulse. Another feature of the training kit is the light indication of the dog in the dark with the aid of powerful LEDs.

Acoustic signal (tone):

All kits in the X25 series enable two types of acoustic signal.

The training acoustic signal () is used as the sound command, which may precede the stimulation impulse and it is a very effective deterrent. Replaces whistle, whose volume the dog perceives in the same manner, even though it is far away.



Localisation () acoustic signal is used to locate a dog in the dark or in dense vegetation. This signal is audible up a distance of 30 m (X25/X25T transmitters) or up to a distance of 300 m (X25B/X25TB transmitters).

Training acoustic signal is activated by the  push button and location sound by pressing  +  push buttons simultaneously.

For the X25B and X25TB transmitters, the volume of both types of acoustic signal can be set in the receiver **MENU**.

For the X25/X25T/X25B/X25TB transmitters, the tone of both the training and localization signals can be changed.

1. Long press the **MENU** push button.

2. Select the  item by using  /  arrows; long press the **MENU**

push button to confirm.

3. Select the transmitter (collar) position you wish to set – [1 to [19; long press the **MENU** push button.
4. Select **tone** by using **▲/▼** arrows, long press the **MENU** push button.
5. By using **▲ / ▼** arrows select **ERA in ING Loudness** or **LOCAL ISAT ion tone** to set the tone type, or **ERA in ING Loudness** or **LOCAL ISAT ion Loudness** to set the volume of the training/location tone. Confirm the selection by long pressing the **MENU** button.
6. Select the type or volume of the tone.
7. By repeatedly pressing **↩** return to the main screen.

Stimulation impulse (IMPULSE): ⚡ (ONLY GPS X25T/X25TB)

This feature enables to activate warning in the transmitter (collar) in the form of safe stimulation impulses transmitted by the two contact points. Stimulation impulses do not hurt the dog. Impulse is very unpleasant to the dog, and consequently, will soon make connection between the oral command, acoustic signal and uncomfortable feeling on the neck.

Setting the pulse size is done in the **MENU** in the same way as selecting the tone type and volume.

Select **IMPULSE** as per **Point 4** and select the impulse strength as per **Point 5**, where 0 means no impulse, 1 is the lowest impulse strength and 15 is the highest.

This command is sent to the transmitter (collar), which is selected on the receiver (handset) navigation main panel by simultaneously pressing the **📶 + FENCE** push buttons.

Light feature (flash): ☀️ (ONLY GPS X25T/X25TB)

The light feature may be used to locate the dog in the dark. The function is activated in **MENU**. The start-up procedure is the same as for the selection of the acoustic signal volume strength, with the difference that in **Point 4**, **FLASH** is selected and in **Point 5**, **00** is selected.

8.3 Compass feature – determining the North

The **N** symbol indicates the direction of the magnetic north. If the two arrows are simultaneously lit, direction to the North is between them.

8.4 FENCE – circular fence/circular acoustic boundary

The FENCE feature alerts you when the dog moves beyond the set area boundary, which is adjustable within the range of 30 m to a maximum of 2 km from the receiver. Circular fence may be activated for more dogs; settings are stored for each dog separately.

If the dog moves beyond the set boundary, the receiver will emit long intermittent beeping and the circle, for this dog, located under the direction indicator will flash on the receiver display. To find out which dog has crossed the set boundary, switch between paired transmitters until you find the flashing circle.

When this feature is turned on, the receiver must have good GPS signal:

1. Select the dog number for which you wish to enable FENCE on the main navigation

panel.

2. Long press the **FENCE** push button.
3. Set the acoustic boundary distance by ▲ / ▼ arrows.
4. Press briefly ↵ to return to the main screen.

After the feature is turned on, **FENCE** is displayed on the main panel display. The top line of the display shows **FENCE** if the feature is activated on at least one of the collars paired with the receiver.

If the receiver starts to emit shorter intermittent beeping, it signifies that the transmitter (collar) or the receiver does not have the GPS or RF signal. This may happen if the dog enters a building where no GPS signal is available, the RF signal is out of range or the dog's transmitter battery is flat.

WARNING: Receiver should have the strongest GPS signal to ensure that the FENCE feature is accurate. If the signal is weak, indication that dog crossed the boundary will not be accurate (given by the GPS accuracy).

NOTE: To use the FENCE and tracking features simultaneously, pair one dog into two positions in the receiver. Then, in one of the positions the FENCE feature may be activated and use the second one for tracking.

Turning off FENCE:

1. Select the dog number for which you wish to disable FENCE on the main navigation panel.
2. Press and hold the **FENCE** push button.
3. Set **OFF** by ▲ / ▼ arrows.
4. Press briefly ↵ to return to the main screen.

8.5 WAYPOINT – saving receiver's position

The waypoint feature enables saving the GPS coordinates of the current receiver (handset) location. Subsequently, you may navigate to the saved location.

Saving waypoint:

1. Hold the **CODE** push button on the receiver for 2 seconds.
2. Select position to which you wish to save the waypoint by ▲ / ▼ arrows. If the position is empty (at given position there is no paired transmitter, other receiver or saved waypoint), the **NO CODE** message is shown on the display.
3. Hold the **MENU** push button for 2 seconds to show **PLACE SAVED**.
4. Press the ↵ push button to return to the main screen.

To navigate to the saved waypoint, select in the main navigation panel by ▲ / ▼ arrows the saved location.

Deleting waypoint:

1. Hold the **CODE** push button on the receiver for 2 seconds.
2. Select position you wish to delete by ▲ / ▼ arrows.
3. Press the button ↵ for a long time – a message **NO CODE** will appear at that position.
4. Press the ↵ push button to return to the main screen.

WARNING: By saving the waypoint to a position where you have a paired transmitter or other receiver, will delete the transmitter (receiver) from the receiver's memory.

8.6 BEEPER feature – indicating standing still

The BEEPER feature is mainly used by gamekeepers/hunters to distinguish the intensity of movement or the presence of a dog near wild pig.

If the transmitter (collar) is turned on and the dog is in motion, the **BEEPER message flashes** in the main navigation window on the receiver display. If the dog does not move or is near wild pig, the **BEEPER is lit continuously**. In the top line of the display, the BEEPER indicates status when the sound or vibration indication is selected for at least one dog on the receiver.

Setting the BEEPER feature:

The indicating standing still feature must be set correctly before hunting commences.

1. Long press the **MENU** push button, select **BEEPER** and confirm by pressing and holding the **MENU** push button.
2. Select the transmitter (collar) for which you wish to set BEEPER. Long press the **MENU** push button.
3. Select the parameter you wish to set by using **▲ / ▼** arrows and confirm by pressing and holding the **MENU** push button.
4. Use the arrows **▲ / ▼** to select the required value or mode. To return to the level above, press **↶**.
5. When the BEEPER is fully set, return to the main screen by pressing repeatedly **↶**.

Setting mode – **IND**

We may select 7 modes:

Mode No.	Description	Indication		Type of hunt
		Motion	Standing still	
	OFF	Beeper flashes	Beeper flashes	-
1	PO int IND-1	-	Acoustic	Bird hunting
2	PO int IND-2	-	Vibration	Bird hunting
3	BOAR-1	-	Acoustic	Hunting wild boars
4	BOAR-2	-	Vibration	Hunting wild boars
5	run-1	Acoustic	-	-
6	run-2	Vibration	-	-

WARNING: The acoustic and vibration indication may be set up for up to 4 dogs. When the sound and vibration indication is set, individual dogs may be identified by the number of beeps/vibrations (max. of 4 beeps or vibrations) indicating dog at motion/standstill. If the acoustic and vibration indication is set for more dogs, the acoustic and vibration indication are simultaneous.

Mode 3 and 4 are intended for hunting wild boars. The indication (acoustic or vibration) is activated if the dog moves within the radius r , for the duration t (time).

Setting of sensitivity – $\text{SE} \text{r} \text{S}$

The sensitivity setting for Mode 0, 1, 2, 5 and 6 is used for more accurate resolution of the dog at motion/standstill.

S-1: Lowest sensitivity – assessment of standstill status may include dog's slight movement.

S-9: High sensitivity – for assessment of standstill status dog must be at absolute rest.

Setting the delay – dELAY

Setting the delay for Mode 0, 1, 2, 5 and 6 – the indication is activated when the dog stays in the given state (motion/standstill) for the set time. The status indication delay is also dependent on the set updating frequency (Paragraph 6.4, Page 10).

Updating frequency [s]	3				6				9			
	1	2	3	4	1	2	3	4	1	2	3	4
Indication delay [s]	7	10	13	16	10	16	22	28	11	20	29	38

The times given in the table are indicative.

Setting the radius – $\text{rAD} \text{r} \text{S}$

Setting the virtual circle radius only relates to hunting wild boars. If the dog stays within this circle for a certain time, the receiver assesses that the dog is in the wild pig vicinity. The circle radius may be set between 5 and 60 m.

Setting the time – $\text{t} \text{r} \text{E}$

Setting the time only relates to the hunting wild boars mode. The indication is activated if the dog stays within the virtual circle for a certain time. The time may be set between 30 and 120 seconds.

NOTE: The activated sound and vibration function can be deactivate while using the BEEPER function by pressing the key \leftarrow . The indication will be deactivated only for the currently selected transmitter, that is currently being displayed in the main navigation menu. After dog's status is changed – movement / standing by, the indicator is activated again.

8.7 CAR mode

Car bodywork and electronics may affect the digital compass function in the receiver – tracked dog direction may not be displayed correctly. When the CAR mode is enabled, the tracked dog direction will not be determined from the digital compass, but from the change in the GPS receiver's position.

Turning the car mode on/off:

1. Press and hold the **MENU** button and select with $\blacktriangle/\blacktriangledown$ the $\text{CAR} \text{ ModE}$ setting.
2. To enable the mode select ON , to disable the mode select OFF .
3. For the correct operation, it is necessary to keep the RF receiver in the direction of

travel and at the same time keep moving (speed higher than 1 m/s). If the receiver is not moving, the arrow will start blinking and keep pointing the last stored direction.

9 MAXIMUM GPS RANGE AND ACCURACY

DOG GPS X25 may be used up to a distance of 20 km (with direct visibility between the transmitter and the receiver). The maximum GPS range and accuracy are influenced by a number of factors – weather, terrain, vegetation, etc.

In dense forest or built-up terrain, the GPS position will be less accurate and the range will be much shorter, which is not due to defective equipment but to physical laws and technical capabilities (within permitted European standards). If the GPS signal is weak, the distance will not be accurate and will vary according to the accuracy of the GPS receiver and the transmitter.

Ensuring maximum range and accuracy:

- Check that the transmitter and the receiver batteries are appropriately charged.
- Fit the transmitter on the dog's neck with the RF aerial pointing upwards.
- Hold the receiver as high as possible with the RF antenna pointing upwards, almost perpendicular to the ground (to be able to recognise the direction on the direction indicator).

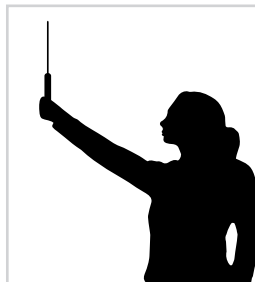

10 TROUBLESHOOTING

1. Please read this Operating Manual again to check whether the problem is caused by the receiver's and/or transmitter's weak batteries and charge them if required.
2. If the device is quickly discharging, the battery's lifespan is near its end; replace it with a new one.
3. If the transmitter battery is quickly discharging, set the longer updating frequency.
4. If the transmitter does not communicate with the receiver, repeat pairing procedure – refer to Paragraph 7.5 *Pairing – encoding transmitter with receiver*, Page 13.
5. In the event that inaccurate indication of the dog's direction from you occurs, carry out the compass calibration again – refer to Paragraph 7.8 *Digital compass calibration*, Page 14.
6. If the device does not show the position exactly, calibrate the compass, find the best GPS signal, and make sure the RF and GPS aerials on both devices are pointing to the sky.
7. If the compass disappears in the receiver's information panel (LCD top line) – CAR MODE is on (Paragraph 8.7).
8. If the problem persists, contact your dealer.

Do not use volatile substances such as thinners, petrol or other cleaning agents to clean DOG GPS X25. Use soft, damp cloth and perhaps neutral detergent, if required. Charge the battery at least once a year if the device has not been used for a long time.

Following the transmitter's battery replacement (unscrewing the plastic cover of the transmitter box), regularly check tightness of the transmitter box screws. Tighten the screws with appropriate force.

WARNING: If moisture penetrates into the transmitter box due to incorrect tightening of the transmitter box screws, any warranty claim will not be accepted.

If the DOG GPS transmitter is used in adverse environment where heavy mechanical wear occurs, the transmitter must be protected – for example by using a protective collar cover, which can be purchased as an accessory. In the event of damage caused by excessive wear, repair under the warranty will not be agreed to.

Localization system **GPS, GALILEO, GLONASS**

Receiver (handheld device)

Power supply	Li-Pol 1900 mAh battery
Battery life per charge	up to 45 hours
Charging time	3 hours
Ingress protection	Waterproof
Operating temperature	-10 °C to +50 °C
Charging temperature	0 °C to 40 °C
Weight	197 g
Dimensions	119 x 62 x 15 mm

Transmitter (collar) **X25/X25T/X25B/X25TB**

Range	up to 20 km (direct visibility)
Power supply	Li-Pol 1900 mAh battery
Battery life per charge	up to 40 hours – position updating frequency 3 s up to 50 hours – position updating frequency 9 s
Charging time	3 hours
Frequency (power)	869.525 MHz (500 mW)
Ingress protection	waterproof
Adjustable belt length	approximately 33–66 cm
Operating temperature	-10 °C to +50 °C
Charging temperature	0 °C to +40 °C
Weight X25/X25T/X25B/X25TB	142/166/154/172 g
Dimensions X25/X25T	77 x 45 x 29 mm / 77 x 45 x 34 mm
Dimensions X25B/X25TB	77 x 45 x 44 mm / 77 x 45 x 49 mm

Main navigation window			Chapter
NO SIG	No signal	No RF signal from transmitter	8.1.
NO GPS	NO GPS	No GPS position for receiver or transmitter	
NEAR	NEAR	Receiver and transmitter are closer than accuracy of GPS positions	
CAL	CAL	Calibration of digital compass in receiver	7.8
Pairing (coding)			
NO CODE	No code	Assigned position has no paired transmitter or saved waypoint	7.5 7.6 8.5
COLLAR SAVED	Collar saved	Assigned position has saved (paired) transmitter (dog collar)	7.5
HUNTER SAVED	Hunter saved	Saving receiver of another hunter in your receiver	7.6
PLACE SAVED	Place saved	Saving waypoint in receiver	8.5
MENU			
TRAINING	Training	Menu for setting of training	8.2
IMPULSE	Impulse	Setting of stimulative impulse	
tone	Tone	Setting the type or volume of training and location tone	
TRAINING tone	Training tone	Setting the tone type	
LOCALISATION tone	Localisation tone	Setting the tone type	
TRAINING Loudness*	Training loudness	Training beep volume level	
LOCALISATION Loudness*	Localisation loudness	Localisation beep volume level	
FLASH	Flash	ON/OFF, lighting function	
BEEPER	Beeper	Menu for beeper setting	8.6
Mode	Mode	Setting of beeper mode	
POINTING-t	Poiting-t	Dog is standing – acoustic indication	

POINTING-V	Pointing-V	Dog is standing – vibratory indication	
BOAR-T	Boar-t	Dog is near wild boar – acoustic indication	
BOAR-V	Boar-V	Dog is near wild – vibratory indication	8.6
RUN-T	Run-t	Dog is running – acoustic indication	
RUN-V	Run-V	Dog is running – vibratory indication	
SENS	Sensitivity	Beeper sensitivity	
DELAY	Delay	Delayed beeper indication	
RADIUS	Radius	Radius of virtual circle	
TIME	Time	Time for which dog must stay in virtual circle	
LOUDNESS	Loudness	Volume of receiver acoustic indication	7.7
LOCATION	Location	Activation of transmitting receiver position	7.6
UPDATE TIME	Update time	Setting the frequency of transmitting the dog's position	7.6
CHANNEL	Channel	A/B channel switching	7.9
CAR MODE	Car mode	Calculation of direction to dog, from change of GPS position	8.7

* Only X25B and X25TB transmitters

VNT electronics s.r.o. provides a 2 year warranty on the **Dogtrace** products with respect to defects in material and workmanship under normal use and service from the date of the original purchase.

The limited warranty does not cover the following:

- straps
- direct or indirect risks during transportation of the product to the retailer
- mechanical damage of the product caused by user's negligence or an accident (eg. biting, breaking, impacts, excessive pulling of d-ring etc.)

1. The warranty period commences on the date of purchase. The sales receipt or your purchase invoice showing the date of purchase of the product, showing the serial number and date of purchase of the product, is the proof of the purchase date.
2. The warranty period does not apply to the reduction in the built-in battery capacity. The battery warranty period is 6 months from date of purchase.
3. The warranty does not cover damage resulting from:
 - a) improper installation or breach of instructions from the manufacturer's user guide
 - b) improper use of the product
 - c) improper storage or maintenance of the product
 - d) modification by a non authorized person, or a repair made without manufacturer's knowledge
 - e) natural disaster (wind, earthquake, lightning storm, etc.)
 - f) alternation of the goods made by the consumer if such an alternation resulted in a damage of the product
 - g) due to a consumer's mechanical damage
 - h) due to excessive wear of the product
 - i) due to other behaviour of the consumer that was in violation of these warranty terms or the instructions for use
4. The warranty can not be claimed if the goods is not completely paid, or when purchased on a sale.
5. The claimant is obliged to prove the defect and to enable the manufacturer to check the legitimacy of the product faults and assess the extent of the product faults. Otherwise is loosing the right arising from the manufacturer's responsibility for product defects.
6. Consumer demands arising from the producer's liability for defects are regulated in the general legislation.
7. It is required that all items being sent for a repair must be properly cleaned. Items deemed to be insufficiently cleaned will be returned unrepared to the customer.
Please do not include the strap or any other accessories if it is not a subject of the warranty.
8. When sending the device to the service with a transport company, pack the goods adequately to protect it against a damage; it is recommended to keep the original packaging for this purpose. The producer is not responsible for a loss of goods during transport.

The information contained in this manual may be subject to change due to developments without further notice.

Copying of this user guide is strictly prohibited without the prior written consent of VNT electronics s.r.o. .