

professional



**d-control**

---

***professional 1000 • mini***  
***professional 2000 • mini***

---

Elektronisches Erziehungshalsband  
Electronic training collar  
Collare elettronico di addestramento  
Collier électronique de dressage  
Elektronische trainingshalsband

---

DEUTSCH

ENGLISH

ITALIANO

FRANÇAIS

NEDERLANDS

## DECLARATION OF CONFORMITY

### Manufacturer:

VNT electronics s.r.o.  
Dvorská 605  
563 01 Lanškroun  
IČO: 64793826

declare under own responsibility that the product:

### Electronic training collar

**Dogtrace d-control professional 1000 / mini**

**Dogtrace d-control professional 2000 / mini**

is in compliance with the essential requirements and other relevant provisions of Directive 2014/53/EC, meets requirements of General Licence of The Czech telecommunication office according to general licence no. VO-R/10/05.2014-3 and corresponds to the following standards:

**ETSI EN 301 489-1 V1.9.2**

**ETSI EN 301 489-3 V1.6.1**

**ETSI EN 300 220-2 V.2.4.1**

**ETSI EN 60950-1 ed.2:2006 /A1:2010 /A11:2009 /A12:2011 /A2:2014/Cor.1:2012**

**EN 62479:2010**



The product is safe under conditions of standard use in accordance with the user guide.

This declaration of Conformity is created in exclusive responsibility of producer.

In Lanškroun 1. 1. 2018

Ing. Jan Horák

executive director

Tel.: +420 461 310 764

info@dogtrace.com

**www.dogtrace.com**

Thank you for purchasing the d-control Dogtrace brand from  
VNT electronics s.r.o.

Before using your product, please read the instructions in this user guide carefully and keep it for future reference.

**VNT electronics s.r.o.**, hereby declares that the **Dogtrace** electronic training collar **d-control professional 1000 / mini** and **professional 2000 / mini** complies with the basic requirements and further relevant regulations of directive **2014/53/EC**.

<b>2 Important notice</b> .....	22
<b>3 ECMA</b> .....	22
<b>4 Introduction</b> .....	23
4.1 Package contents .....	23
4.2 Optional accessories .....	24
<b>5 Product description</b> .....	24
5.1 Transmitter .....	24
5.2 Receiver .....	25
<b>6 Transmitter preparation</b> .....	25
6.1 Battery insertion and replacement .....	25
6.2 Checking the transmitter battery status .....	25
6.3 Transmitter settings .....	26
<b>7 Receiver preparation</b> .....	26
7.1 Battery insertion and replacement .....	26
7.2 Checking the receiver battery status .....	27
7.3 Switching the receiver on/off .....	27
7.4 Pairing the receiver with the transmitter .....	28
7.5 Choice of the contact points .....	29
7.6 Fitting the training collar .....	29
<b>8 The basics of training collar usage</b> .....	30
8.1 Transmitter – button functions .....	30
<b>9 For the best results</b> .....	33
9.1 Maximum transmitter range .....	33
9.2 Using training collar in winter .....	33
<b>10 Troubleshooting</b> .....	34
<b>11 Maintenance</b> .....	35
<b>12 Technical data</b> .....	35
<b>13 Warranty terms and conditions</b> .....	36
<b>14 Certificate of warranty</b> .....	94



dog training  
basic commands

dogtraceofficial



- The electronic training collars d-control are intended only to train animals. They are not intended to harm, injure or to cause fear.
- Do not use the electronic training collars for dogs with health problems (e.g. heart disease, epilepsy, etc.) or for dogs with behavioral disorders (aggressive dogs etc).
- The collar should never be worn for more than 12 hours a day. Long-term effect of contact points on the dog's skin can cause skin irritation. If a rash or sore skin is found, do not use the collar until it has healed.
- Never connect a leash to the electronic collar; this could cause excessive pressure on the contact points or mechanical damage of the receiver.
- In case of any problems or for further advice do not hesitate to contact a professional trainer.
- Do not place the transmitter close to objects which are sensitive to magnetic field, this could cause a permanent damage.
- Receiver and transmitter batteries need to be replaced every two years, even if the kit has not been used. Never leave flat batteries inside of the device - it could damage your device.
- The person with a personal instrument to support heart activity (pacemaker, defibrillator) must respect the relevant precautionary measures. The d-control professional emits a certain stationary magnetic field.



**VNT electronics s.r.o.**, professional producer of the dog training equipment, which is manufactured and sold under the brand name Dogtrace, is a proud and active member of the **Electronic Collar Manufacturers Association**.

ECMA was founded in Brussels in 2004 as a result of increasing awareness from different manufacturers concerning the necessity of regulating their industry. The main target of the association is to develop and produce reliable training systems of high quality, which are safe for the animals and improve the communication between pets and their owners. All members of the ECMA provide you with both technical and training guides that contain instructions and advice for safe use of electronic training equipment and enable all dog owners to use the training systems in an effective, responsible and humane way. All ECMA member's products meet the latest technical requirements which ensure minimum production standards and safety features and enable training while protecting animal welfare.

The ECMA is convinced that the electronic training collars are effective and humane training tools when used responsibly and combined with an appropriate reward.

For more information please visit [www.ecma.eu.com](http://www.ecma.eu.com).

The electronic training collar Dogtrace d-control professional, consisting of the transmitter and the receiver, is a modern, safe, reliable and effective training tool. d-control training collar enables you to make corrections that are suited to your dog's temperament and the distraction level of the moment, at the right time and with maximum training efficiency. However, making corrections to your dog's unwanted behaviour is only a small part of what you can do with the d-control.

#### **Features of d-control professional 1000 / mini, 2000 / mini**

The electronic training collar d-control professional is variable and impact resistant device. Waterproof receiver and transmitter is designed mainly for a professional sport and police training. d-control professional can be also used in everyday life during common training. This model with a range of 1000 m or 2000 m will allow an individual setting of four function buttons. Each function button can be set to any function as follows: audible beep tone, stimulation impulse in 40 levels (momentary and continuous) vibration or light. It is possible to use the d-control professional to train one or two dogs at once.

- range up to 1000 m or 2000 m (depending on the model)
- impact resistant transmitter construction
- waterproof transmitter and receiver
- 8 modes of light and 4 modes of vibration
- 2 modes of audible beep tone – momentary/continuous
- momentary and continuous stimulation
- 40 stimulation levels
- expands to train two dogs
- optionally adjustable function buttons
- possibility to program one receiver with two transmitters

#### **4.1 Package contents**

- Transmitter
- Belt clip (including 2 screws)
- Receiver (with the strap)
- 2 pairs of contact points (12 mm and 17 mm)
- 2 alkaline AAA 1,5V batteries
- Lithium battery CR2 3V
- Test discharge lamp
- Lanyard
- User guide and certificate of warranty
- Carrying case



## 4.2 Optional accessories

- Dummy receiver (with the strap)
- Spare batteries
- Spare screws
- Spare rubber seal for the transmitter and the receiver
- Spare contact points (12, 17 and 21 mm)
- Woven and plastic collars – various colours

# 5

## PRODUCT DESCRIPTION

### 5.1 Transmitter

1. Integrated antenna
2. Function buttons A1/A2 - dog A
3. Function buttons B1/B2 – dog B
4. LCD
5. Target (round red indicator) indicating where the magnetic switch is located
6. Button  – for power ON/OFF (long press), or to choose function buttons A1/A2/B1/B2 (short press)
7. Button  – to choose a command for function buttons A1/A2/B1/B2
8. Buttons for adjusting the mode level of the function buttons
9. Belt clip
10. Strap eyelet
11. Battery cover

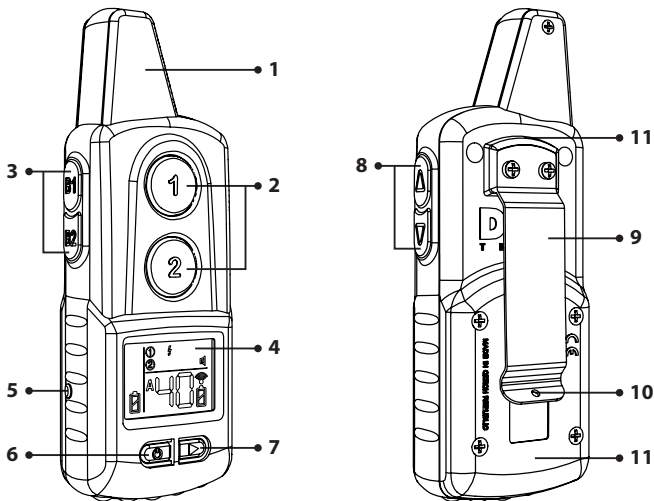

## Display

1. Command indicator of function buttons A1 or B1
2. Command indicator of function buttons A2 or B2
3. Transmission indicator
4. Current button setup indication
5. Battery power indicator
6. Indicator of mode or stimulation level
7. Locking of selected function and command

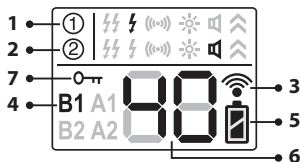

## 5.2 Receiver

1. Contact points
2. Strap
3. Target (red indicator) indicating where the ON/OFF magnetic switch is located
4. LED indicators

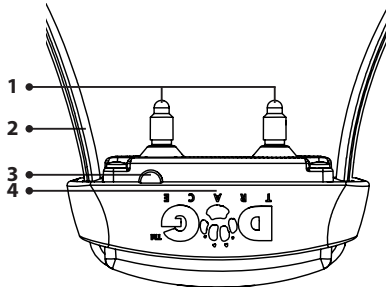



## 6 TRANSMITTER PREPARATION

### 6.1 Battery insertion and replacement

1. Screw out 4 screws from the battery cover using a cross-head screwdriver and remove the lid.
2. Insert two alkaline AAA batteries into the battery compartment with a correct polarity (according to the polarity indicated with the "+" symbol in the battery compartment). Wrong polarity may damage the unit.
3. Make sure that the rubber seal is clean and correctly seated in its groove.
4. Put the battery cover back and screw in the 4 screws adequately.



### 6.2 Checking the transmitter battery status

The battery power indicator on LCD shows the battery status:

-  – Fully charged battery
-  – Medium charged battery
-  – Flat battery







If the battery is flat, insert new AAA alkaline batteries into the battery compartment.

### 6.3 Transmitter settings

1. **Switching ON/OFF** – press down for 1 second the button .
2. **Selection of function button for setting** – by pushing this button  shortly and repeatedly you switch between buttons A1/A2/B1/B2.

Buttons A1/A2 are designed for a dog A and buttons B1/B2 are designed for a dog B.

**TIP:** When using the device for training one dog, you can program function buttons B1/B2 with the same receiver (collar) as function buttons A1/A2 - see chapter 7.4 *Pairing (programming) function buttons B1/B2 (or second transmitter) with the first receiver.*

3. **Command setting** – by pressing down  button you can choose a command for the selected function button A1/A2/B1/B2. Selected command will be sent to the receiver collar. You can select following commands:
  - continuous stimulation and short nick stimulation, vibration, light, beep and external device.
4. **Mode and stimulation level setting** – use / buttons for impulse intensity setting or for mode setting.
5. **Locking of selected function and command** – by pushing  button continuously, the selected button function will be locked. Locked mode is indicated by this symbol  on the screen. After you have locked those buttons, you can set only level of a current selected function button. By pressing following symbol  continuously you can open transmitter setting again.

## 7 RECEIVER PREPARATION

### 7.1 Battery insertion and replacement

1. Screw out 4 screws from the battery cover using a cross-head screwdriver and remove the lid.
2. Insert the lithium CR2 3V battery into the battery compartment with a correct polarity (according to the polarity indicated with the "+" symbol in the battery compartment – see the Fig.). A wrong polarity may damage the unit.

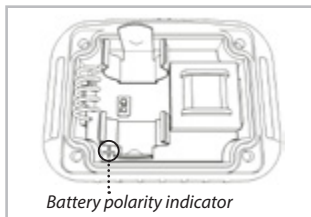
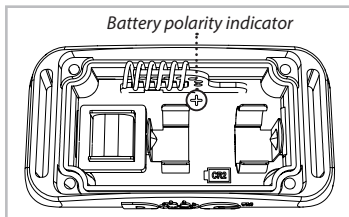

When you insert the battery for the first time, or if the battery is removed longer than a few tens of minutes (approximately 20 minutes), you will hear an audible beep tone indicating the correct installation of the battery.



**Note:** When you replace the battery quickly, you may not hear the audible beep tone of the collar.

3. Make sure that the rubber seal is clean and correctly seated in its groove. Clean any dirt from the seal.
4. Put the battery cover of the receiver back and screw in the 4 screws adequately.

## 7.2 Checking the receiver battery status

The status of the battery is indicated by LED indicators on the side of the receiver. (see chapter: *5.2 Product description – Receiver*)

**The battery is fully charged** – when switched on, green LED is flashing

**The battery is low** – when switched on, red LED is flashing

When the battery is low or flat, insert a new CR2 3V lithium battery into the receiver.

## 7.3 Switching the receiver ON/OFF

To turn the receiver ON/OFF (or for programming the transmitter with the receiver) is used a magnetic switch, marked with the red target on the receiver.

### Switching ON

1. Move the red target of the transmitter towards the receiver so it comes into the contact with the red target of the receiver. The red LED indicator of the receiver will lit up, afterwards the green LED indicator will lit up.
2. When the green LED lighted up, move your transmitter away from the receiver. The receiver LED indicator will flash green to indicate the receiver is ON.

### Switching OFF

When switching OFF, follow the same steps as when switching ON.

1. Move the red target of the transmitter towards the receiver so it comes into the contact with the red target of the receiver. The green LED indicator of the receiver will lit up, afterwards the red LED indicator will lit up.
2. When the red LED is lighted up, move your transmitter away from the receiver. The receiver LED indicators will stop flashing.

**Important:** When turning the receiver ON/OFF hold the red target of the receiver close to the red target of the transmitter for about 1 second. When the targets are close to each other for longer than 5 seconds the receiver will switch to the pairing (programming) mode of the transmitter with the receiver. This programming mode is indicated by alternate flashing of the red and green LED indicator. If this occurs, follow the chapter *7.4 Pairing (programming) the transmitter with the receiver.*

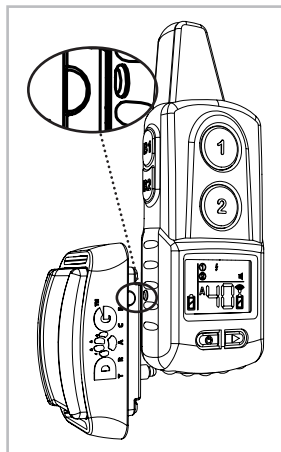

## 7.4 Pairing (programming) the receiver with the transmitter

Each transmitter has its own radio operational code. The programming of the transmitter with the receiver enables those two units to work together. When purchasing new d-control professional set, there is no need to program the device. The set is programmed from the manufacture. In case you want to use another transmitter or receiver, you need to program the devices together. Programming is also necessary for using all four function buttons with one receiver. d-control professional is compatible with other d-control professional models.

The transmitter is designed for training two dogs, so you can pair it with two receivers. Function buttons A1/A2 are designed for the dog A and function buttons B1/B2 for the dog B.

**Important:** Before the programming make sure no one else is using his d-control professional or other products from the Dogtrace range close by. Your receiver could accidentally record the code of his transmitter or interference could occur. This could someone else transmit some commands into your receiver. If this occurs, program once again the communication of your receiver with your transmitter.

### Pairing (programming) function buttons A1/A2 with the first receiver

1. Turn ON your transmitter.
2. **The receiver must be turned OFF.**
3. Move the red target of the transmitter towards the receiver so it comes into the contact with the red target of the receiver and hold for 5 seconds. The red LED indicator of the receiver will lit up, afterwards the green LED indicator will lit up.
4. After 5 seconds the receiver LED indicators will flash 3 times green and red colour simultaneously. Afterwards the green and red LED indicators will start alternately flashing.
5. Press down A1 or A2 button.
6. Successful pairing is indicated by a long beep tone of the receiver.

### Pairing (programming) function buttons B1/B2 with the second receiver

Proceed in the same way as in the previous chapter, only in the point 5 press down the function button B1 or B2.

When you want to use the transmitter for training only one dog, it is possible to program all four function buttons A1/A2/B1/B2 with the one receiver. You can also use this function for the professional training and for programming communication of one receiver with two different transmitters.

### Pairing (programming) function buttons B1/B2 (or second transmitter) with the first receiver

1. Turn ON your transmitter.
2. **The receiver must be turned ON.**
3. Move the red target of the transmitter towards the receiver so it comes into the contact with the red target of the receiver and hold for 5 seconds. The green LED indicator of the receiver will lit up, afterwards the red LED indicator will lit up.

4. After 5 seconds the receiver LED indicators will flash 3 times green and red colour simultaneously. Afterwards the green and red LED indicators will start alternately flashing.
5. Press down B1 or B2 button (or any other function button on the second transmitter).
6. Successful pairing is indicated by a long beep tone of the receiver.

**Warning:** If you program the receiver from the switched OFF status (see the chapter *7.4 Pairing (programming) function buttons A1/A2 with the first receiver*), the device that was programmed from the switched ON status will be automatically removed (mostly used to remove the trainer's transmitter from your receiver after the training is finished).

## 7.5 Choice of the contact points

The stimulation is transferred on your dog's skin through the steel contact points of the receiver. Each set contains 2 types of contact points. Sufficient length of the contact points has to have a contact with the dog's skin, enabling the device to operate correctly. If you have a short-haired dog use the 12 mm contact points, if you have a long-haired dog replace them with the longer 17 mm contact points supplied in the kit. Screw the contact points onto the screws of the receiver - see the picture *5.2 Receiver* in the chapter *5 Product description*, page 25. Tighten them manually carefully (do not use a pliers – this could damage the product).

**TIP:** If your dog has very long hair, you can order 21 mm long contact points. When your dog has a dry skin in the area where the contact points are, it is good to lubricate the dog's skin with a vaseline, hand cream, or baby oil - which enables a correct transfer of stimulation impulses.

## 7.6 Fitting the training collar

The strap (receiver collar) with the receiver collar must be tightened enough so that the contact points are in contact with the skin of the dog. We recommend you to fit the collar on the standing dog. When you can fit two fingers between the collar and your dog's neck, the collar with the receiver are tightened enough. If a dog has long or thick hair, it is suitable to trim the hair in the area of the contact points or to switch to the longer contact points to ensure a consistent contact.

**Warning:** If the collar is too loose, the receiver is likely to move and repeating friction can irritate the skin of your dog. Furthermore, in this case it is not ensured a reliable contact of contact points with the skin and a proper function of the training collar. We do not recommend to leave the collar positioned at the same place for more than several hours, because it could irritate the skin. If it is necessary to wear the collar for long periods, change regularly the position on the neck of your dog. A collar with a receiver that is overly tight, can cause pressure sores on the skin in the contact area of the contact points. If this happens, do not use the training collar until all traces of irritation are gone.

## 8 THE BASICS OF TRAINING COLLAR USAGE

- The trainer's elementary knowledge of the dog training is the prerequisite for using the training collar.
- If you don't have this knowledge, we recommend you to contact a training center, a cynology club, or a school for dogs where you will learn the basic communication with your dog.
- You can start using the collar for the 6 months old dog, which have undergone the basic training and is familiar with basic obedience commands including „sit“, „down“, „stay“ or at least „stop it“, „leave it“.
- Require these commands along with the audible beep tone, so your dog will create a connection between them.
- After a command that is successfully executed, you should always reward or encourage your dog, so the dog will be happy to fulfill your commands and a desire to fulfill your commands will grow.
- You must not consider the executed command as the absolute obviousness and punish disobedience - your dog would soon lose an interest.
- If you are not sure that your dog will obey you after recall, start training e.g. on a tracking rope.
- Your dog will have to get used to the collar; let the dog wear the collar for a few days, but do not use it so that your pet does not discover the connection with its attachment and effects.
- Affirmative and efficient training requires some time: don't hurry!
- Select a well-known environment your dog is used to.
- Choose the right moment to press the button; exactly at the moment when your dog does something what is not allowed.
- In case of any problems and for further advice, please do not hesitate to contact a professional trainer.

### 8.1 Transmitter – button functions

#### Audible beep tone:

The receiver on dog's collar begins to emit an audible beep tone (an acoustic signal). This command can precede a stimulation impuls. It is also a very effective warning tool. You can use the acoustic signal instead of the command: Come! / Heel! In this case it replaces a whistle, the dog always perceives its sound in the same intensity. It's very important always to use the beep sounds in the same way in order not to confuse your dog. While transmitting the audible beep tone, the green LED indicator of the receiver is emitting a light.

Mode	Audible beep tone	Limit
1	long	30 s
2	momentary (electronic clicker)	–

**Momentary / continuous stimulation:** ⚡ – ⚡⚡

This function enables you to activate a safe stimulation warning impulses in the receiver transmitted by two contact points. The purpose of stimulation impulses is not to hurt the dog, but this impulse is very unpleasant for your dog. Your dog will soon create a connection between your command, an audible beep tone and the unpleasant feeling on the neck. Later on, you will use only a minimum of these stimulation impulses because the dog will connect them with disobeying your command.

While transmitting the stimulation impulse, the red LED indicator of the receiver is emitting a light.

**Momentary** – stimulation impulse takes only 0,1 second no matter how long the button is held.

**Continuous stimulation** – a receiver emits a stimulation impulse as long as the button is pressed, but for safety reasons, it is limited to 8 seconds.

**Choice of stimulation level:**

It is important to choose the right intensity of the stimulation impulse for your dog, therefore it is gently adjustable in 40 levels. Because every dog has a different sensitivity, you can not estimate the proper stimulation level in advance. Begin at the lowest levels. If your dog does not respond at a low level, increase it gradually until you can see a moderate reaction. The stimulation impulse should never cause your dog a pain or a fear.

**TIP:** The command stimulation impulse in level 00 does not emit any stimulation impulses. If you do not want to use the stimulation impulses, set a short and a long stimulation impulse on the 00 intensity.

**Funktion der Vibration:** ((••))

This function enables you to draw an attention of sensitive dogs or dogs with a hearing malfunction. It ensures a discreet recall of the dog, which is almost impossible by deaf dogs and which can not be heard by anyone nearby. It provides a possibility to disturb the dog during an unwanted activity and to use the moment of a surprise. Each mode can mean a different command.

Mode	Vibration	Period	Limit
1	discontinuos vibration	0,5 s	30 s
2	continuous vibration	–	30 s
3	3x	0,5 s	–
4	short	0,2 s	–

While transmitting the vibration, the red LED indicator of the receiver is emitting a light.

## Lichtfunktion:

For an easy localization of your dog in the dark, this function provides several modes of LED light. The LED - diodes are placed in the transparent receiver housing of the collar. The transmitter also allows you to set a different interval of flashing when using two collars at the same time - you can easily spot your dogs according to the flashing interval (example: a dog A - flashes once in a second and a dog B - flashes once in two seconds).

Mode	Light is flashing	Period	Limit
1	as long as the button is pressed down and held	0,5 s	30 s
2	after the button is pressed down, the light starts flashing *	2 s	-
3	2x	0,5 s	-
4	10x	2 s	-
5	as long as the button is pressed down and held	0,1 s	30 s
6	after the button is pressed down, the light starts flashing *	1 s	-
7	2x	0,1 s	-
8	10 x	1 s	-

\* Flashing is switched off by repetitive pressing down the button

**Warning:** Function light considerably loads an accumulator, which may lead to a fast discharge of the receiver, even though the battery indicator lights showed that the battery is in the norm. **The battery is probably discharged if the light function does not work.**

## External device:

This function is used to control other devices.

### 9.1 Maximum transmitter range

The training collar d-control professional 1000 / mini, 2000 / mini can be used up to 1000 m or 2000 m working range. The maximum range depends on many factors - weather, terrain, vegetation and so on.

To ensure maximum working range of the device:

- Do not cover the transmitter antenna
- When transmitting commands, hold the transmitter in a vertical position, away from the body and above your head
- Check the battery in the transmitter and in the receiver, replace it if necessary.

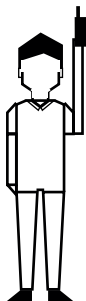

*maximum range*

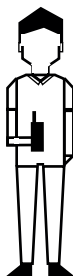

*regular range*

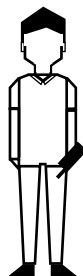

*minimum range*

### 9.2 Using training collar in winter

When using d-control in winter, please keep in mind:

- **Low humidity** – causes less skin conductivity. It is necessary to provide better conductivity between the contact points of the receiver and the dog's skin. This can be achieved by lubricating the dog's skin in the touching points of the contact points with vaseline, baby oil, hand lotion, etc.
- **Thicker fur dog** – it is necessary to tighten the collar so that the permanent contact with the dog's skin is ensured. If the fur is too thick, it is recommended to cut the hair or choose a longer type of contact points.
- **Battery features change** – temperatures below 0 °C slow down chemical reactions in batteries. To ensure a performance of repetitive stimulation impulses (especially of higher levels), it is recommended to insert a new battery into the receiver for the winter time. During the training, observe continuously dog's reactions and increase the stimulation level as needed.

1. Read again this user guide and make sure the problem is not caused by a flat battery or incorrect use.
2. Make sure the batteries are inserted with the correct polarity.
3. **If the transmitter does not communicate with the receiver, try to program communication** - see chapter: *7.4 Pairing (programming) the transmitter with the receiver*.
4. If it seems, that the dog does not respond to the stimulation impulse:
  - Check again the battery in the transmitter and in the receiver.
  - Test the receiver's functions with a test discharge lamp (see 5<sup>th</sup> paragraph of this chapter).
  - Check whether you have chosen correct length of the contact points (see chapter: *7.5 Choice of the contact points*) and ensure contact points are well tightened and in contact with your dog's skin (see chapter: *7.6 Fitting the training collar*).
  - If the dog has dry skin, moisten the skin.

**5. Check the correct function of the stimulation impulse.**

By using test discharge lamp you can easily check correct function of the momentary/continuous stimulation impulse.

- Make sure that the receiver is turned OFF.
- Place the test discharge lamp in contact with each of the contact points - loosen the contact points, insert the lamp's outlets under (the contact points so they are in the touch with the screw and tighten them (see picture).
- Turn on the transmitter and the receiver.
- Select momentary or continuous stimulation for any function button.
- The test discharge lamp will increase a light intensity when increasing stimulation level.

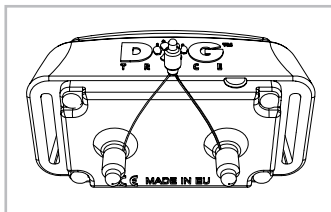

**Note:** The receiver does not emit any stimulation impulse, when setting the level 00. When using the test discharge lamp the stimulation impulses come on with less intensity than without the testing lamp.

6. If the problem still persists, contact the dealer.



It is important to keep the device clean. Never use volatile substances eg.: thinner, gasoline or other cleaners. To clean your Dogtrace d-control use a soft, damp cloth and, if necessary, neutral detergent.

**The transmitter and the receiver (collar) Dogtrace d-control professional is waterproof only on condition of the good state of the seal. We recommend you to replace the rubber seal, which is placed under the cover of the battery compartment of the transmitter and the receiver, once a year.** Clean the rubber seal and make sure that the rubber seal is correctly seated in its groove every time you change the batteries; tighten the screws using adequate power.

If the device is not used for a longer time, take out the batteries from the battery compartment.

#### Transmitter

Range .....	1000 - 2000 m (depending on model)
Power supply .....	2 x AAA 1,5 V battery
Battery life .....	6 - 12 months, based on usage
Frequency .....	869,525 MHz (100 mW)
Antenna .....	integrated
Tightness .....	waterproof
Operating temperature .....	-10 °C to +50 °C
Weight .....	125 g (without the batteries)
Dimensions .....	113 x 53 x 29 mm (without the antenna)

#### Receiver (collar) d-control professional/professional mini

Power supply .....	CR2 3 V lithium battery
Battery life .....	6 months, depending on usage
Antenna .....	integrated
Tightness .....	waterproof
Adjustable belt length .....	approximately 33 – 66 cm
Operating temperature .....	-10 °C to +50 °C
Weight .....	65 g / 45 g (without the battery and contact points)
Dimensions .....	77 x 39 x 33 mm / 61 x 40 x 31 mm

VNT electronics s.r.o. provides a 2 year warranty on the **Dogtrace** products with respect to defects in material and workmanship under normal use and service from the date of the original purchase.

The limited warranty does not cover the following:

- accumulators
- straps
- direct or indirect risks during transportation of the product to the retailer
- mechanical damage of the product caused by user's negligence or an accident (eg. biting, breaking, impacts, excessive pulling of d-ring etc.).

1. The warranty period commences on the date of purchase. The sales receipt or your purchase invoice showing the date of purchase of the product, showing the serial number and date of purchase of the product, is the proof of the purchase date.

2. The warranty does not cover damage resulting from:

a) improper installation or breach of instructions from the manufacturer's user guide

b) improper use of the product

c) improper storage or maintenance of the product

d) modification by a non authorized person, or a repair made without manufacturer's knowledge

e) natural disaster (wind, earthquake, lightning storm, etc.)

f) alteration of the goods made by the consumer if such an alteration resulted in a damage of the product

g) due to a consumer's mechanical damage

h) other customer's process, which would be in a contrary to the Warranty terms and conditions and the User guide

3. The warranty can not be claimed if the goods is not completely paid, or when purchased on a sale

4. The claimant is obliged to prove the defect and to enable the manufacturer to check the legitimacy of the product faults and assess the extent of the product faults. Otherwise is loosing the right arising from the manufacturer's responsibility for product defects.

5. Consumer demands arising from the producer's liability for defects are regulated in the general legislation.

**6. It is required that all items being sent for a repair must be properly cleaned. Items deemed to be insufficiently cleaned will be returned unrepared to the customer. Please do not include the strap or any other accessories if it is not a subject of the warranty.**

7. When sending the device to the service with a transport company, pack the goods adequately to protect it against a damage; it is recommended to keep the original packaging for this purpose. The producer is not responsible for a loss of goods during transport.

*The information contained in this manual may be subject to change due to developments without further notice.*

*Copying of this user guide is strictly prohibited without the prior written consent of **VNT electronics s.r.o.***